

Art. 656145

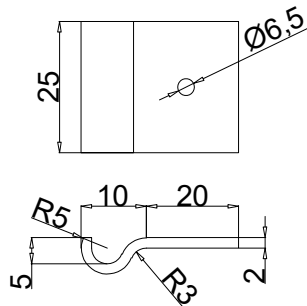

DETTAGLIO
CLIP DI
AGGANCIAMENTO

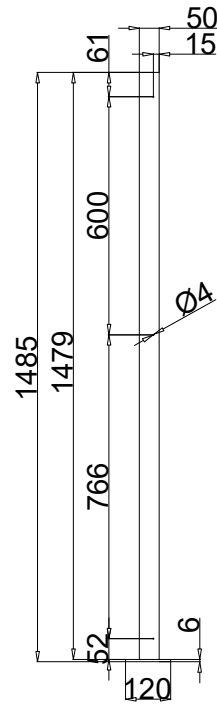
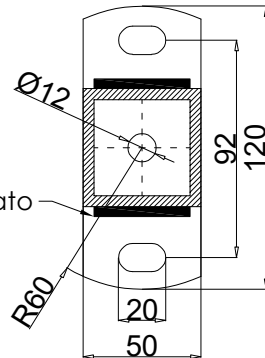

DETTAGLIO
PIASTRA
MONTANTE

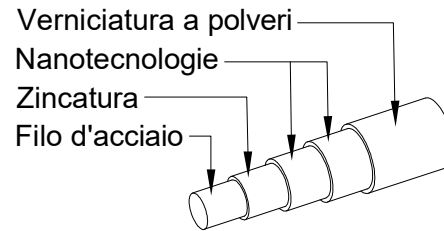
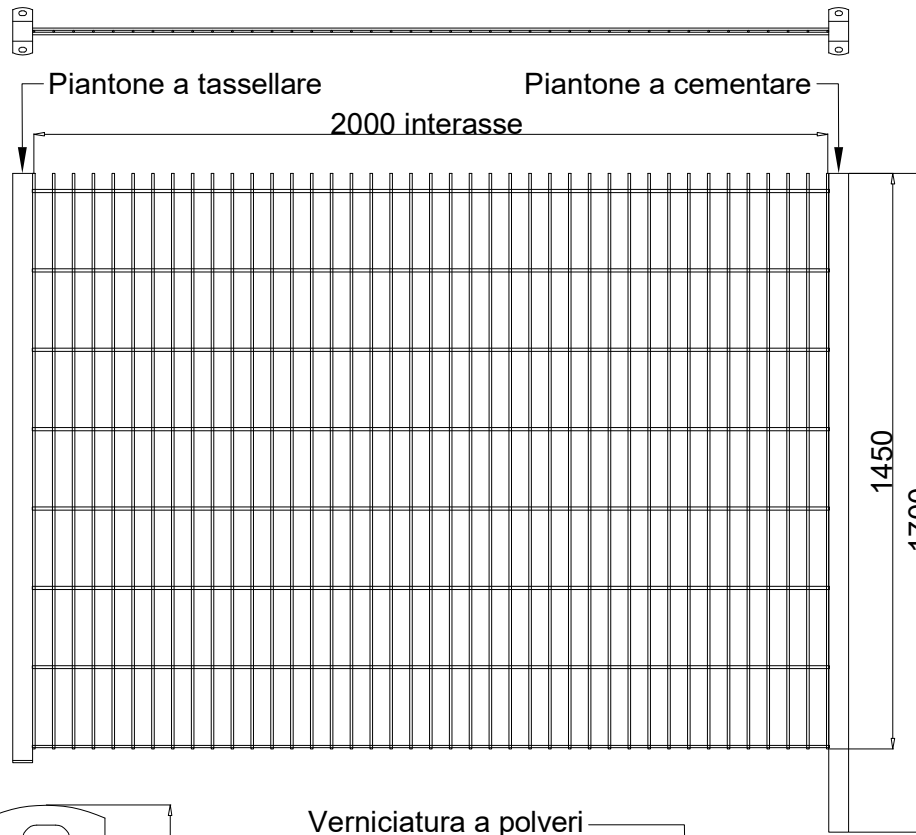

DETTAGLIO RIVESTIMENTO

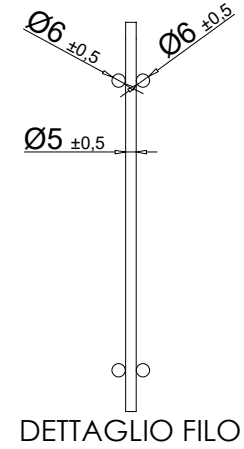

DETTAGLIO FILO

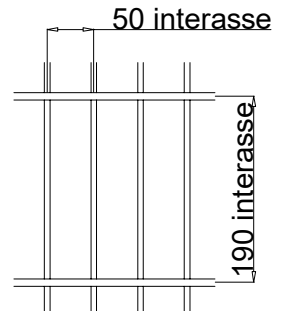
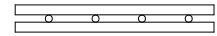

DIMENSIONI MAGLIA

DESCRIZIONE: PANNELLO RECINZIONE R656 IN DOPPIO FILO DIMENSIONI h1450 x 2000			
TRATTAMENTO:	ZINCATO E VERNICIATO	COLORE:	GRIGIO - VERDE
Ø FILO:	VERTIC. Ø 5 mm / ORIZ. Ø 6 mm	DIMENSIONI PIANTONI:	50 x 50 mm
NR. FILI ORIZZONTALI:	16 PZ	NR. FILI VERTICALI:	41 PZ
		PESO PANNELLO:	13,00 KG ±10%
		LUNGHEZZA TOTALE FILI:	91562 mm

SoloRecinzioniCancelli

ART. P1485 FEG/FEV
ART. P1485 FCG/FCV
ART. 656145 FEG/FEV

NOTE:
- Dimensioni maglia: tolleranze come da EN 10223-7
- Larghezza e altezza pannello: tolleranze come da EN 10223-7

La ditta si riserva la proprietà di questo disegno con divieto di riprodurlo o trasferirlo a terzi senza autorizzazione scritta.